

SEISMIC SAFETY ANALYSIS OF ARCH DAMS:  
FACT OR FICTION?

Ray W. Clough

Nishkian Professor of Structural Engineering  
Earthquake Engineering Research Center  
University of California  
Berkeley, California - U.S.A.

RESUMEN

El estado del arte en los procedimientos de elementos finitos para evaluar la respuesta sísmica de diques en arco es presentado, teniendo en cuenta la interacción del dique con la roca de fundación y con el agua retenida. Los buenos resultados obtenidos con los procedimientos usados son demostrados por la correlación de los resultados analíticos con los datos obtenidos en ensayos con vibraciones forzadas. Sin embargo se hace notar que estos procedimientos analíticos pueden no ser igualmente efectivos en predecir la respuesta de diques en arco sometidos a movimiento sísmico. Deficiencias en la manera que el sismo es introducido en la base son discutidas, y procedimientos para mejorar la aplicación de los sismos son presentados, pero es necesario realizar mas investigaciones antes de que se puedan derivar conclusiones finales.

ABSTRACT

The state of the art of finite element procedures for evaluating the earthquake response of arch dams is presented, taking account of the interaction of the dam with its foundation rock and reservoir water. The generally good performance of current procedures is demonstrated by correlation of analytical results with measured data from forced vibration field tests. It is pointed out, however, that these analytical procedures may not be equally effective in predicting the response of arch dams to earthquake input. Deficiencies of the standard seismic input mechanism are discussed, and several improved procedures are described, but further research is required before final conclusions may be drawn.

## INTRODUCTION

As a consequence of increasing concern for the hazard posed by a major dam, due largely to increasing population downstream, safety evaluations are now being performed for many dams in the United States [1]. If the dams are located in seismic regions such as California, a seismic safety analysis is an important part of the overall safety evaluation. Therefore, the earthquake response behavior has been evaluated recently for many existing arch dams, as well as for several proposed new designs; and it is pertinent to consider how reliable the results of such analyses may be.

It is apparent that an arch dam poses a complex dynamic response problem, partly because of the relatively complicated three-dimensional geometry of the dam itself, but more importantly because the rock walls of the canyon as well as the reservoir water interact with the dam motions. However, the field of computational mechanics and the available computer hardware capabilities have now advanced to the point where such complex interaction problems can be analyzed on a routine basis [2], so it would seem that we should have complete confidence in the results of an arch dam seismic response analysis.

The reason for the concern about such results implied by the introductory comments becomes apparent if we examine the analytical process in detail. The essential steps are:

- (1) definition of the physical problem to be solved, including both the earthquake input mechanism\*, as well as the geometry and properties of the responding systems,
- (2) formulation of a discretized mathematical model to represent the specified system and its earthquake input,
- (3) calculation of the dynamic response of the mathematical model to the specified earthquake input,
- (4) extrapolation of the calculated mathematical model results to the actual physical prototype.

The field of computational mechanics provides the means for performing steps 2, 3, and 4 of this sequence, and present capabilities for carrying out such analyses are outstanding; in general this phase of the analytical procedure can be considered to be reliable. The main difficulty, and this is particularly true for arch dam systems, lies in the first step: describing precisely the problem which is to be solved mathematically. Specifically, the choice of boundary conditions which emulate the behavior of the unbounded real system, the definition of the seismic input mechanism and the selection of appropriate material properties will control the validity of the results that are obtained.

The purpose of this paper is to describe in a general way the earthquake response analysis of arch dams, with emphasis on present practice rather than on the latest research results. Typical assump-

\*It is evident that the selection of the earthquake acceleration history is a major source of uncertainty in the results, but that factor is not considered in the present discussion.

tions made in defining the problem will be discussed in detail, but the standard procedures used to formulate the mathematical model of the specified system and to carry out its analysis will only be mentioned. Following this preliminary explanation, two specific examples will be presented. These are two arch dams in China which have been the subject of a research program that was carried out as a U.S.-China cooperative project. In this study, the results of dynamic analyses of the dams have been correlated with data obtained in a field test program; thus the capabilities of present analysis techniques are demonstrated, at least to a limited extent. However, it must be noted that this experiment involved only harmonic excitation of the crest of the dam; thus the capability of performing an earthquake response analysis is not demonstrated by this correlation. In the final section of the paper, the problem of specifying the seismic input mechanism for an arch dam is discussed. Various earthquake input procedures that are in present use are described, and comments are made on their deficiencies. Then a suggestion is made for an improved procedure that overcomes most of these deficiencies. It must be emphasized, however, that this proposed procedure has not yet been applied even though the concepts on which it is based are well known; the software to carry out the analysis is not yet available.

#### TYPICAL SEISMIC ANALYSIS PROCEDURE

The four steps of the general earthquake response analysis procedure, as typically applied at present, will be described with reference to the idealized arch dam system depicted in Fig. 1.

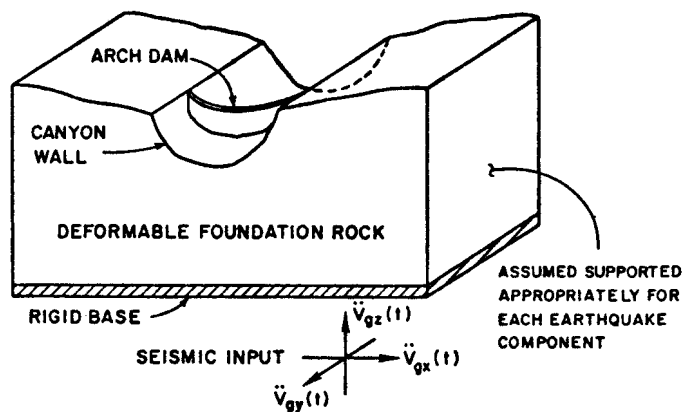

Fig. 1 Physical System Considered in Arch Dam Analysis

### Definition of the Physical System

Note that to a large degree, the critical first step in the analysis already has been taken in drawing this sketch. The actual dam is built in topography and geological structure which for practical purposes may be considered to extend to infinity both horizontally and downward. The vertical side surfaces and horizontal rigid base depicted in the sketch obviously are not real, so a mathematical model that faithfully reproduces the behavior of the pictured system can represent reality only to the extent that these boundaries can approximate the true boundary behavior. In order to minimize the distortion introduced by the assumed side boundaries, edge supports are introduced which limit the face motions in a reasonable way. In principle, the response to each of the three indicated earthquake components should be evaluated separately, using different side face node support conditions for each case -- selected according to concepts of symmetry and antisymmetry.

The rigid base indicated for this system imposes the condition that the same earthquake motions act over the entire base of the model. The motions may be specified separately for the two horizontal motion components and for the vertical component, and any desired time history of acceleration may be prescribed for each component, but the assumption of a rigid base imposes a major constraint. Fortunately, data obtained with a sophisticated seismograph array in Taiwan [3] indicate that this rigid base motion is a reasonable assumption for some earthquakes where the earthquake focus is directly beneath the site. However, records obtained from other types of earthquakes demonstrate a horizontal propagation component which obviously is not consistent with the rigid base assumption. This traveling wave problem is beyond the present state of the art of arch dam analysis, although some research is being done on the subject.

### Formulation of the Mathematical Model

In present practice, the mathematical model generally is established by the finite element method, using meshes of 3D solid elements for both the dam and the foundation rock, and employing the values of modulus of elasticity and mass density specified during the problem definition. The end results of this formulation are the mass matrix  $\underline{m}$  and the stiffness matrix  $\underline{k}$  of the combined dam-foundation system, expressed in terms of the finite element nodal displacements  $\underline{u}$ .

The interaction effect of the reservoir generally is represented by the Westergaard added mass concept [4], which leads to a set of lumped masses defined for the finite element nodes at the face of the dam. These added masses  $\underline{m}_a$  then are merely combined with the coefficients of the concrete mass matrix defined for the corresponding degrees of freedom. Because the original Westergaard concept was derived for a dam with rigid vertical face moving into the reservoir in the direction normal to the face, various modifications have been employed to account for the curved face geometry and actual flexibility of the arch dam; however none of these modifications is fully effective. The most advanced level of current practice is to represent the reservoir by a mesh of incompressible liquid elements [5], taking account of the dam face geometry as well as the reservoir topography for a reasonable distance upstream. The end result again is an added mass matrix which is combined with the

concrete mass coefficients identified at the dam face nodes.

#### Formulation and Solution of Equation of Motion

The result of the finite element discretization is a set of equations of motion which may be written as follows:

$$[\underline{m} + \underline{m}_a] \ddot{\underline{u}} + \underline{c} \dot{\underline{u}} + \underline{k} \underline{u} = - [\underline{m} + \underline{m}_a] [\underline{r}_x \ddot{v}_{gx} + \underline{r}_y \ddot{v}_{gy} + \underline{r}_z \ddot{v}_{gz}] \quad (1)$$

in which  $\underline{c}$  is the damping matrix,  $\underline{r}_x$ ,  $\underline{r}_y$  and  $\underline{r}_z$  are displacement influence coefficient vectors indicating the values of the displacements  $\underline{u}$  resulting from unit values of the base displacement components  $v_{gx}$ ,  $v_{gy}$  and  $v_{gz}$ , and the dots denote differentiation with respect to time.

Generally, it is assumed that the damping matrix is of the proportional type and that the dynamic response behavior is linear, so that the equations of motion may be uncoupled by transforming to vibration mode coordinates. This transformation is expressed by

$$\underline{u}(t) = \sum_{n=1}^M \phi_n Y_n(t) \quad (2)$$

in which  $\phi_n$  is the  $n^{\text{th}}$  mode shape vector and  $Y_n(t)$  is the corresponding modal amplitude at time  $t$ . Only  $M$  of the lower modes are considered in an earthquake analysis because the higher modes make a negligible contribution to the response. Because of the orthogonality properties of the mode shapes, the equations of motion became a set of independent equations each representing the response of a single mode. For the  $n^{\text{th}}$  mode, the equation may be written

$$\ddot{Y}_n + 2\xi_n \omega_n \dot{Y}_n + \omega_n^2 Y_n = P_n(t) \quad (3)$$

in which  $\xi_n$  is the modal damping ratio and the modal earthquake load is given by

$$P_n(t) = - \phi_n^T [\underline{m} + \underline{m}_a] [\underline{r}_x \underline{r}_y \underline{r}_z] \begin{Bmatrix} \ddot{v}_{gx} \\ \ddot{v}_{gy} \\ \ddot{v}_{gz} \end{Bmatrix} \quad (4)$$

Each of the modal equations (Eq. 3) is solved for the modal response,  $Y_n(t)$ , usually by a time-stepping procedure, and then the finite element coordinate response for each instant of time,  $\underline{u}(t)$ , is obtained by superposition of the modal responses as indicated by Eq. 2. Of course the final step in a seismic safety analysis is to evaluate the element stresses from the nodal displacements so that the probability of dynamic rupture may be determined. It is apparent from this brief description that the formulation of the equations of motion as well as their step-by-step solution are standard routine procedures, and the stress results that are obtained should be a close approximation of the stresses that would be developed in the specified physical system due to the assumed earthquake input. The uncertainty that exists in the analytical results is due almost entirely to the assumptions made in defining the physical system and its earthquake input mechanism.

U.S.-CHINA COOPERATIVE RESEARCH PROJECT

Project Background

In order to get a better understanding of the limitation of this standard seismic analysis procedure when applied to arch dams, and also with the hope that various aspects of the procedure could be improved, a cooperative research project was initiated in 1981 under the U.S.-China Protocol for Scientific and Technical Cooperation in Earthquake Studies. The cooperating institutions were the Earthquake Engineering Research Center (EERC) of the University of California, Berkeley, and the Scientific Research Institute for Water Conservancy and Hydroelectric Power (SRIWCHP) together with Tsinghua University, both of Beijing, China. The Principal Investigators were Professors K. T. Chang of Tsinghua University and R. W. Clough of the University of California. Financial support for the U.S. part of the effort was provided by the U.S. National Science Foundation; the Chinese activities were supported by the Ministry of Water Conservancy and Electric Power. The principal objectives of the research were to obtain improved understanding of the dynamic interaction mechanisms between an arch dam and its foundation rock, as well as between the dam and its reservoir water; and also to develop dynamic response analysis procedures that would represent the interaction mechanisms more realistically and conveniently.

The research effort involved performing harmonic forced vibration tests of two arch dams in China, using the SRIWCHP vibration test system and data acquisition system supplemented by specialized EERC transducers and recorders. Then the corresponding analytical results were evaluated at the EERC, using University of California computer systems and programs. The first dam to be studied was Xiang Hong Dian (XHD), a single curvature gravity arch located in Anhui Province. During the second year, Quan Shui (QS) dam was tested; this is a thin shell double curvature dam in Guangdong Province. The experimental and analytical procedures employed in these two studies and the correlation results are presented in References 6 and 7, respectively. Only a brief summary of the work will be given here; this is intended to demonstrate both the capabilities and some of the limitations of the analytical procedures presently in use.

Test Procedures

The vibration properties of the test structure were measured by the harmonic excitation method, producing the motions by means of synchronized rotating mass shaking machines constructed by SRIWCHP. In the test of XHD dam, four of these shakers were bolted to the crest of the dam, spaced at equal intervals symmetrically about the mid-section. Only two shakers were used in testing QS dam because of the relatively lighter weight of this structure.

The response at the crest of the dam was measured as the test frequency was changed by increments. The result is a frequency response curve for the structure in which the natural frequencies are indicated by peaks in the curve. Figure 2 shows a frequency response curve obtained by symmetric excitation of XHD dam; the antisymmetric modes were obtained similarly using antisymmetric excitation. After the natural frequencies were identified, the vibrating shape for

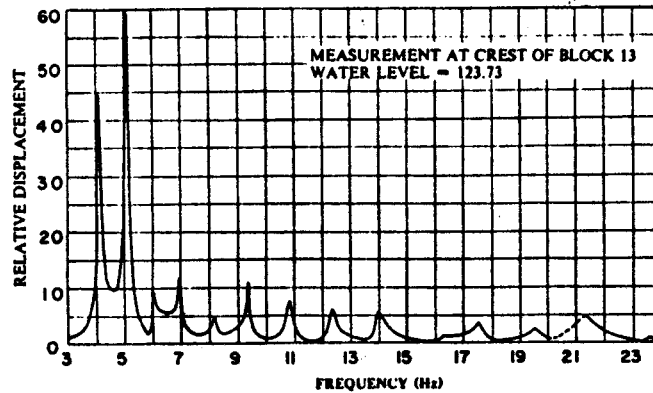

Fig. 2 Variation of Crest Displacement with Exciting Frequency

each frequency was determined by measuring the amplitude of response at numerous points on the dam and in the foundation rock while the excitation was maintained at the specified frequency. In addition, in order to study the reservoir interaction, the hydrodynamic pressure amplitudes were measured for each frequency at many points on the face of the dam as well as within the reservoir.

#### Mathematical Model

The finite element model used to represent each of the test dams was produced by the mesh generator subroutine of the arch dam analysis program ADAP [8]. Using the coordinates of the circular arc centers at selected horizontal sections as well as of points on the abutments at corresponding levels, the subroutine produces a mesh of 16 node isoparametric elements each having quadratically curved upstream and downstream faces, together with linear interpolation through the thickness of the dam. Figure 3 depicts the elements defined to

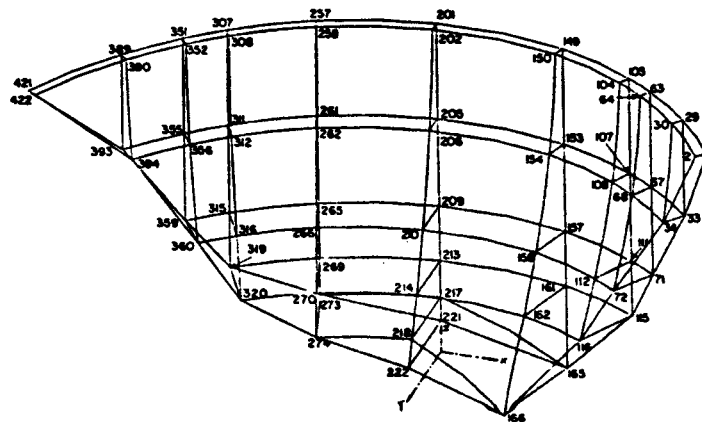

Fig. 3 Finite Element Model of Xiang Hong Dian Dam

represent XHD dam, while Figure 4 is the corresponding mesh for QS dam. It will be noted that this latter mesh is complicated by the addition of solid elements at each side of the downstream face to represent the spillway blocks at these locations.

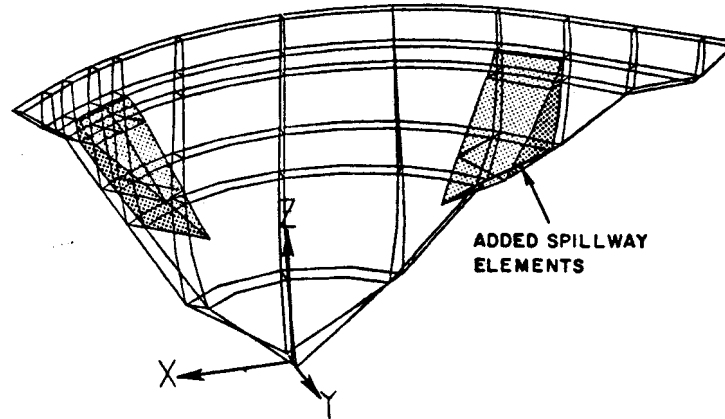

Fig. 4 Finite Element Model of Quan Shui Dam

The foundation model provided in the ADAP program is an assemblage of 8 node isoparametric solid elements, extending upstream, downstream, and into the rock beneath the dam for a distance equal to the height of the dam. This semicircular foundation block section follows the contact surface between dam and rock all around the canyon, and is assumed to be rigidly supported at the nodes on its outer surface. Figure 5 depicts the foundation block defined for the right half of the canyon wall; the block for the left half is similar.

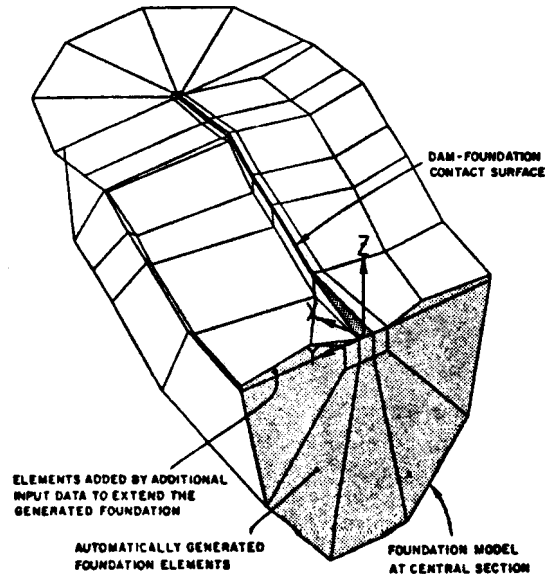

Fig. 5 Finite Element Model of Foundation Block for Quan Shui Dam



In the improved program presently being developed, called ADAP-II, the reservoir is modeled by incompressible liquid finite elements. The mesh of these 16 node isoparametric elements matches the mesh of concrete elements at the dam face; at other reservoir sections upstream the mesh is similar except that it is adjusted to fit to topography at the selected sections. In general, it has been found that the incompressible liquid model need not extend upstream more than about three times the reservoir depth. Figure 6 shows the liquid

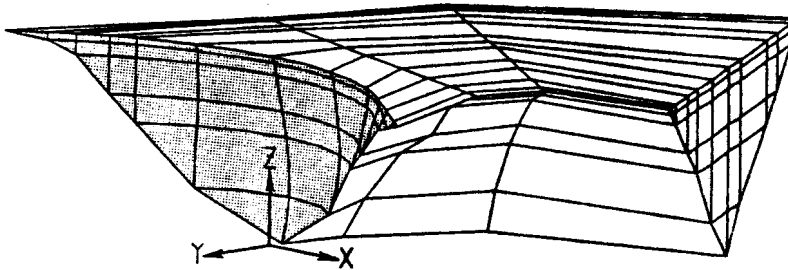

Fig. 6 Liquid Element Mesh of Quan Shui Reservoir

element mesh adopted for QS dam. A major advantage of the incompressible liquid assumption is that the model can be reduced by static condensation to a set of equivalent added mass coefficients defined at the dam face. Then these added reservoir masses need only to be added to the concrete mass coefficients defined for the corresponding degrees of freedom at the dam face.

#### Correlation of Results

The vibration properties of the combined dam-foundation-reservoir system are calculated in the ADAP program using a standard eigenproblem solution subroutine. The elastic properties used for the concrete and rock were based initially on data derived from tests on samples of the materials; however, in this project the Young's modulus values were adjusted later to give a good match between the calculated and measured values of frequencies for the lower modes. Table I shows the frequency correlation that was attained for XHD dam; experimental frequencies were evaluated both from the harmonic tests and also by analysis of ambient vibration behavior. Correlations of some of the lower vibration mode shapes for QS dam are presented in Figure 7. It should be noted that the mass density of the concrete

Table I Correlation of Calculated and Measured Vibration Frequencies for Xiang Hong Dian Dam

Mode No.	Vibration Frequencies - Hz		
	Measured		Calculated
	Forced	Ambient	
1	4.1 (S)	3.94	3.99
2	4.3 (A)	4.25	4.36
3	5.1 (S)	5.05	5.17
4	6.0 (A)	5.95	6.01
5	7.0 (S)	6.87	7.50

S (A) denotes Symmetric (Antisymmetric) Excitation

used in these analyses was based on sample tests; however, it was assumed that the foundation rock was massless. The reason for this assumption will be explained in the following chapter on seismic input assumptions.

After the mathematical model for each dam had been defined, the frequency response curve was calculated, including crest motion amplitude due to crest excitation forces applied at varying frequencies. The damping used in the analysis was adjusted to give the same peak harmonic response as had been observed in the tests. Comparisons of the calculated and measured frequency response curves for two of the lower modes of QS dam are shown in Fig. 8; the viscous damping ratio obtained by this analytical procedure is seen in the graphs to be consistent with that determined experimentally by the "half-power" method [9].

The correlation of measured and calculated mode shape and frequency results had been carried out for numerous dams prior to this test program, so the relatively good agreement between the two types of data was not unexpected. Of greater interest in this project was the reservoir interaction mechanism, and to evaluate the analytical reservoir model used in this study, the hydrodynamic pressures measured in the reservoir during harmonic excitation were compared with corresponding pressures predicted analytically. Unfortunately, the waterproofing of the pressure gages failed during the test of XHD dam, so only limited experimental data was obtained in that test. However, this defect was corrected before the tests were performed on QS dam, so a full set of hydrodynamic pressure data was obtained for that case.

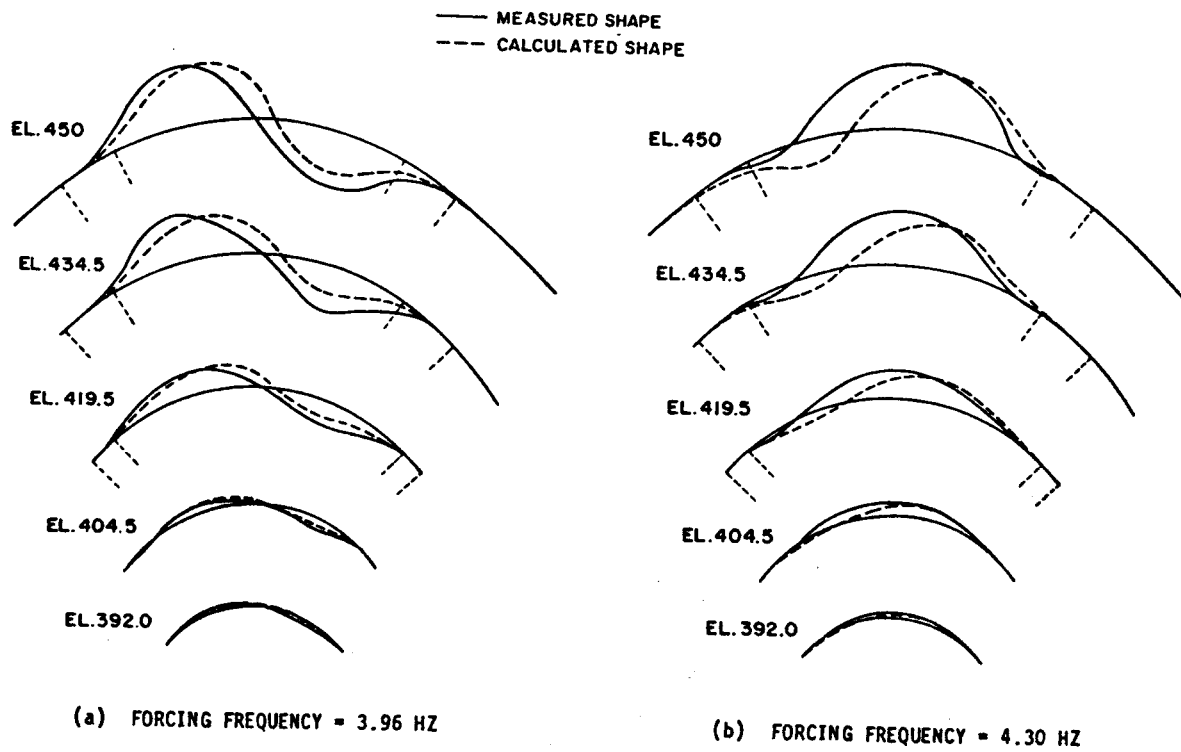

Fig. 7 Correlation of Measured and Calculated Forced Vibration Shapes - Qian Shui Dam

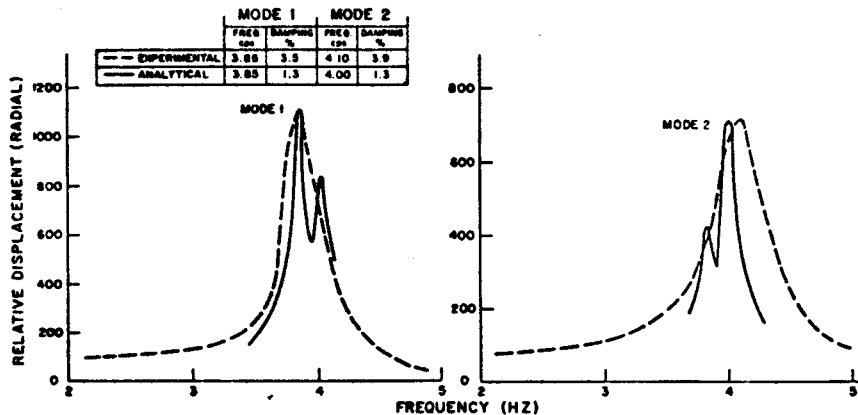

Fig. 8 Correlation of Experimental and Analytical Displacement Frequency Response Curves - Quan Shui Dam

Figure 9 demonstrates the pressure correlation that was obtained for XHD dam. It is apparent from these rather limited results that

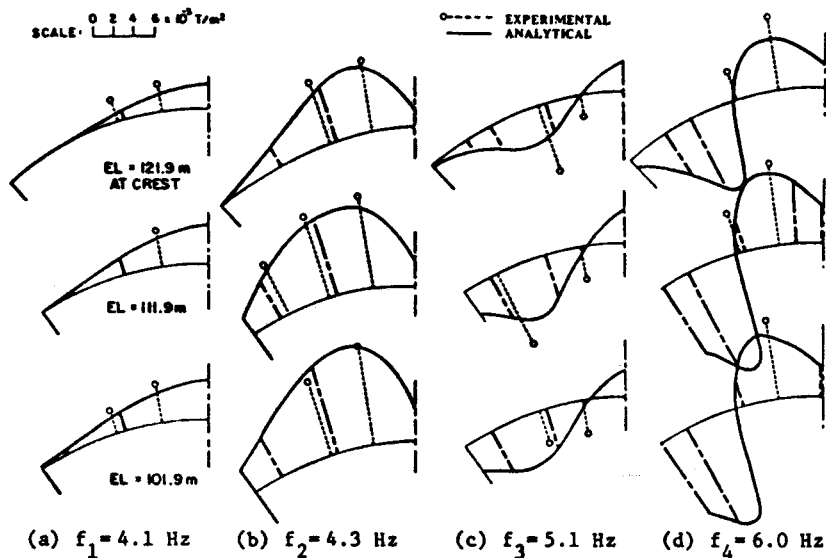

Fig. 9 Correlation of Forced Vibration Hydrodynamic Pressures Xiang Hong Dian Dam

the measured pressures are slightly larger than the calculated values; however, in view of the fact that this type of correlation had not been attempted previously for a full scale dam, it was concluded that the analysis had given quite good results. Thus at this stage of the research, the incompressible reservoir model appeared to be adequate. However, when the corresponding pressure correlation was done for QS dam, with the results as shown in Fig. 10, it became apparent that the analysis greatly underestimates the hydrodynamic pressures in this case. The reason for this significant discrepancy is not yet known, but it seems likely that it is due to the neglect of liquid compressibility in the analytical model. An unanswered question at this time is why the reservoir resonance effects that can result from compressibility are so much more prominent for QS dam than for XHD dam.

#### Discussion

From the results presented here, as well as considering the corresponding correlations for all the measured vibration modes for both dams, it can be concluded that the finite element models depict the forced vibration behavior of the dams with good accuracy. The discrepancies tend to increase for the higher modes, as is to be expected, but the first five or six modes are defined quite well; in general this is enough modes to predict the earthquake response behavior with adequate precision.

Of course, it must be recognized that the test data has been used to define the assumed material moduli of elasticity, and such data is not available for use in typical seismic safety analyses. However, the first mode frequencies obtained with the initially assumed Young's moduli differed from the final adjusted modulus results by only about four and two percent, respectively, for the XHD and QS dams.

The Young's modulus adopted for the foundation rock in these analyses should be viewed as an effective modulus, which compensates to some extent for the assumed boundaries of the foundation block. Measurements of forced vibration motions at stations located in the foundation rock along the downstream river channel (Fig. 11) show that measureable motions are present at distances significantly beyond the assumed foundation block boundary. However, this barely discernible motion obviously can have little effect on the much greater motions induced in the dam itself; moreover, they do not imply any significant radiation energy loss as is apparent from the small damping values determined at these harmonic excitation tests.

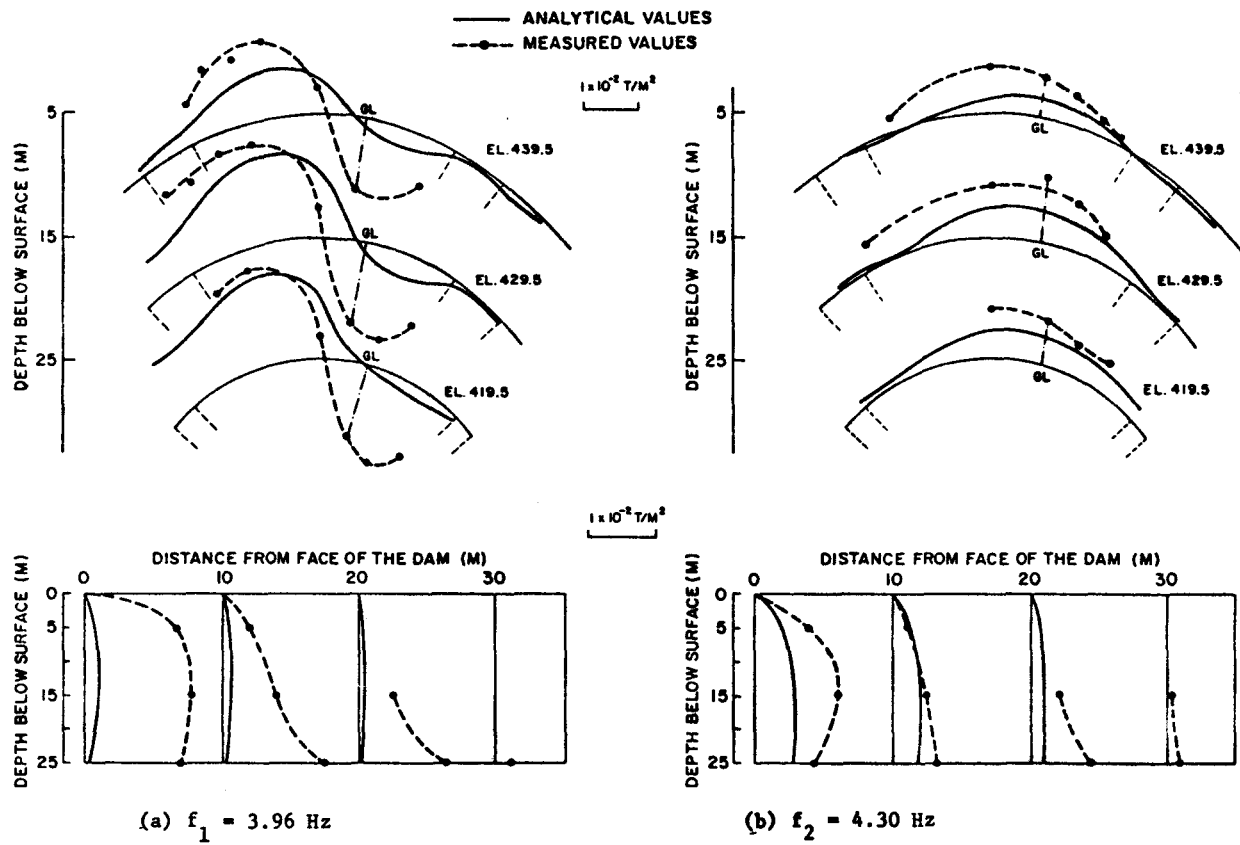

Fig. 10 Correlation of Forced Vibration Hydrodynamic Pressures - Quan Shui Dam

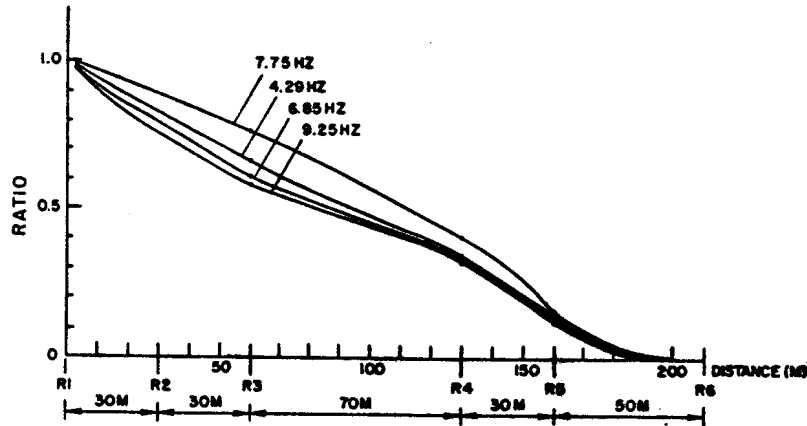

Fig. 11 Forced Vibration Displacement Amplitude in River Channel Variation with Distance Downstream from Quan Shui Dam

#### SEISMIC INPUT

It was pointed out in the Introduction that the relatively good correlation of analytical and experimental results obtained in this investigation demonstrates the effectiveness of the mathematical model in evaluating response to harmonic excitation applied at the crest. However, it cannot be assumed a priori that the model will be equally valid for seismic response analysis. In particular, it must be noted that the foundation rock in the model merely provides a flexible support system in the case of crest excitation, but in an earthquake it also serves to transmit the earthquake motions from the base rock to the dam.

The modelling of the earthquake input mechanism has received relatively little attention during the development of seismic analysis procedures for arch dams. However, recent exploratory studies of two-dimensional systems have demonstrated that the manner of applying the seismic input may lead to dramatic variations in the dynamic response [10], and it is presumed that similar response variations might result in the earthquake analyses of three-dimensional arch dam models. Accordingly, a number of different input assumptions that have been used or proposed for use in seismic analysis of arch dams will be discussed in the following paragraphs. Unfortunately, comparative analyses have not yet been performed, applying these different input mechanisms to the same arch dam; consequently conclusions cannot yet be drawn. However, it is important to identify the factors that can lead to such variations in the calculated response.

### Standard Model

The physical system depicted in Fig. 1 and described earlier may be considered as the standard earthquake input mechanism; the prescribed earthquake motions are applied by the rigid base that underlies the foundation rock. The major deficiency of this approach is that the earthquake applied at the base generally is an acceleration history that actually was recorded at the ground surface. Typically, the recorder was in a "free-field" location, where the ground motions would not be influenced by adjacent structures or topographic features; however the record is of surface motions rather than motions at significant depth.

The problem with this earthquake input procedure is that the motions at depth are significantly different from the motions that would result at the ground surface. The vibratory waves in the foundation rock are modified as they propagate upward, so if the measured free field motions are applied at the base, the resulting free field motions at the surface of a uniform rock layer generally would be considerably amplified. The net effect is that the dam is subjected to seismic input greater than is intended by the free field motion input at the base. Of course, the canyon topography and the presence of the dam would cause further distortion of the base input motions, but such distortions would also take place in reality and are an intended effect of the mathematical model.

### Massless Foundation Rock Model

A modification of the base rock input mechanism described above was proposed in the late 1970's [11], and has been used extensively for arch dam analyses since then. The only differences in this case is that the deformable foundation rock is assumed to be massless; thus it functions only as a spring system in the foundation interaction mechanism. Obviously the absence of mass has no effect on a static analysis, but in an earthquake response analysis the earthquake forces applied to the rigid base rock are transmitted instantaneously through the foundation rock to the base of the dam, without any wave propagation effects. In this case it is appropriate to apply free field surface motions at the base rock because the earthquake forces to which the dam is subjected are closely related to these surface effects.

### Deconvolution Analysis of Base Rock Input

A more direct means to avoid the amplification problem resulting from wave propagation effects in the foundation rock is to make a preliminary deconvolution analysis of the base motions that might have produced the free field motions. Typically it is assumed that the deformable foundation rock is a horizontally stratified geological structure, extending to infinity in the horizontal directions as indicated in Figure 12. Then the motions at the surface that would result from a specified base motion input could be calculated by a one-dimensional wave propagation procedure; or alternatively, in the case where the surface (free field) response is known, the corresponding base rock motions can be evaluated by deconvolution [12].

The purpose of the deconvolution analysis is to obtain a reasonable estimate of the base motion from the measured surface motion,



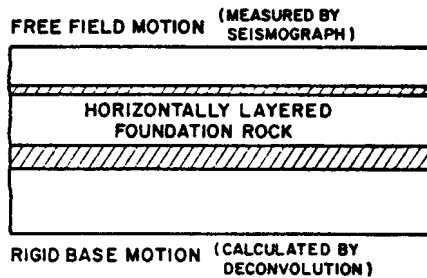

Fig. 12 One-Dimensional Deconvolution Model of Foundation Rock

taking account of the modification of the motions resulting from the wave propagation effects. When this more representative base motion has been determined, it can be applied as the base input to the mathematical model of Fig. 1, in which the foundation rock is assumed to have both normal mass and stiffness properties. Then the wave propagation resulting from the base input leads to appropriate reflection and refraction effects at the canyon walls and dam interface, simulating the true dynamic behavior.

#### Free Field Arch Dam Input

Applying the deconvolved base motions as the seismic input as described above is a rational procedure, and should lead to a valid estimate of the arch dam response. However, the analysis would be rather expensive because of the very large number of degrees of freedom associated with the deformable foundation rock in Fig. 1. One of the advantages of the massless foundation is that the foundation degrees of freedom can be eliminated by static condensation, leading merely to a set of effective spring coefficients at the dam interface. Thus the size of the foundation model is of little consequence in the massless foundation case, but it leads to orders of magnitude increases in the computation cost if foundation mass is considered.

A more efficient alternative is to evaluate the free field motions at the canyon wall without the dam in place, and then to use these motions as the seismic input to the arch dam. The procedure would be to first evaluate the base motions by deconvolution of a free-field surface record, and then to use a two-dimensional canyon model, as depicted in Fig. 13, to calculate the free field motions at the canyon walls. The assumption that the canyon geometry is constant in the upstream-downstream direction permits the two-dimensional analysis of the response, with great savings in computational cost as compared with a three-dimensional system.

The final step in this type of earthquake analysis would be to use the calculated canyon wall motions as free-field input to the

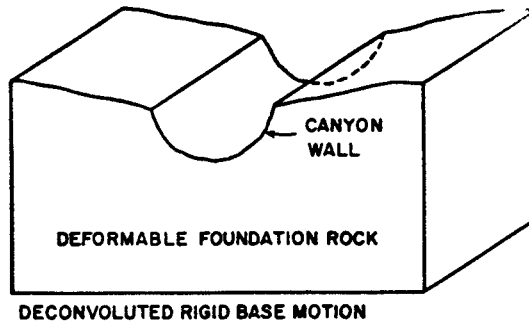

Fig. 13 Two-Dimensional Canyon Wall Free Field Motion Model

combined dam-canyon system. As described in Reference 9 (pp.584-588), the seismic input then is applied only at the degrees of freedom on the interface between dam and canyon wall. The typical ADAP foundation model (Fig. 14) with its relatively few degrees of freedom would be appropriate for use in this type of seismic input analysis.

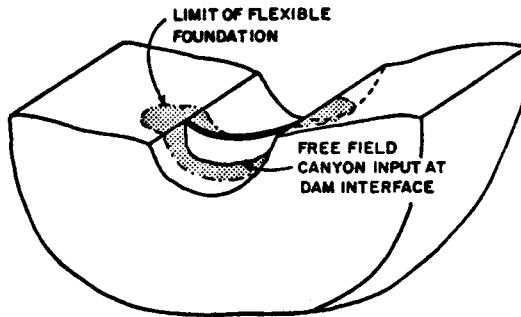

Fig. 14 ADAP Foundation Model for Free Field Canyon Wall Input

#### CONCLUSIONS

The purpose of this paper has been to present a critical evaluation of the procedures employed in earthquake response analyses of arch dams, and to give an idea of the reliability of the results of such analyses. In general, the most significant results of the analysis are estimates of the maximum stress that may be developed in the dam, considering the combined effects of the dynamic earthquake response together with a critical combination of static loads. In

most cases, only the tensile stress is likely to approach the strength capacity of the concrete; if the strength is exceeded cracking will occur and in general this is interpreted as failure.

Correlation of field experiment results with analytical predictions, as described here, tends to give confidence in the dynamic modeling and response analysis procedures, although further research must be done before the limitations of the incompressible reservoir model are fully understood. However, the correlations discussed here only substantiate the ability to predict low amplitude response to harmonic crest excitation. Whether the large amplitude response induced by an intense local earthquake can be evaluated effectively is still a matter of conjecture. In any case, it seems that the "standard" procedure for applying the earthquake input cannot be considered reliable. Alternate procedures certainly should be considered, and the free field canyon wall input appears to offer a reasonable and efficient approach to the analysis. Efforts should be directed toward analytical testing of this procedure, followed by its incorporation into a standard arch dam analysis program such as ADAP.

In closing it should be emphasized that all analysis procedures discussed here are based on linear elastic response behavior. This assumption undoubtedly is reasonable for evaluation of the response to harmonic test excitations, but a major earthquake can be expected to cause significant nonlinearities (Ref. 11). The best that can be expected from a linear analysis in such cases is an indication of whether the tensile strength of the concrete is likely to be exceeded. As mentioned above, if excessive tensile stresses are predicted by the linear analysis it is assumed that cracking will occur, and generally such cracking is considered to be unacceptable performance.

Clearly it must be recognized, however, that a cracked dam is not necessarily a failed dam; it still can perform the function of retaining the reservoir. In many cases, it is in such interpretation of the analytical results that the greatest question enters the seismic evaluation process. Much more research must be done to understand the degree of cracking and damage that an arch dam can accommodate without loss of reservoir, and until such studies have been made it will not be possible to determine whether seismic safety judgements about arch dams are fact or fiction.

#### REFERENCES

- [1] Dams and Public Safety by R. B. Jansen, U.S. Dept. of Interior, Water and Power Resources Service, 1980.
- [2] Numerical Methods in Coupled Systems by R. W. Lewis et al., John Wiley and Sons, Ltd., Chichester, England, 1984.
- [3] Bolt, B. et al., "Preliminary Report on the SMART-I Strong Motion Array in Taiwan", University of California, Earthquake Engineering Research Center Report No. UCB/EERC-82/13, August 1982.
- [4] Westergaard, H. M., "Water Pressures on Dams during Earthquakes," Trans. ASCE, Vol. 98, 1933.

- [5] The Finite Element Method in Engineering Science by O. C. Zienkiewicz, McGraw-Hill Book Company, London, 1971 (p.330-332).
- [6] Clough, R. W. et al., "Dynamic Response Behavior of Xiang Hong Dian Dam," University of California, Earthquake Engineering Research Center Report No. UCB/EERC-84/02, April 1984.
- [7] Clough, R. W. et al., "Dynamic Response Behavior of Quan Shui Dam," University of California, Earthquake Engineering Research Center Report No. UCB/EERC-84/20, November 1984.
- [8] Clough, R. W. et al., "ADAP - A Computer Program for Static and Dynamic Analysis of Arch Dams," University of California, Earthquake Engineering Research Center Report No. UCB/EERC-73/14, 1973.
- [9] Dynamics of Structures by R. W. Clough and J. Penzien, McGraw-Hill Book Company, New York, 1975.
- [10] Clough, R. W. and Liu, H.-W., "A Study of Seismic Input Mechanisms for Arch Dam Analysis," Proceedings, 19th Midwestern Mechanics Conference, Ohio State University, Columbus, Ohio, Sept. 1985.
- [11] R. W. Clough, "Nonlinear Mechanisms in the Seismic Response of Arch Dams," Proceedings, International Research Conference on Earthquake Engineering, Skopje, Yugoslavia, June-July 1980.
- [12] P. B. Schnabel et al., "SHAKE - A Computer Program for Earthquake Response Analysis of Horizontally Layered Sites," University of California, Earthquake Engineering Research Center Report No. UCB/EERC-72/12, December 1972.